



Oras

Installation and maintenance guide



4-15



16-24

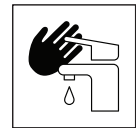

25

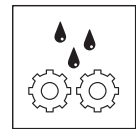

26-33



34



Oras App



apps.oras.com

Apple and the Apple logo are trademarks of Apple Inc., registered in the U.S. and other countries. App Store is a service mark of Apple Inc., registered in the U.S. and other countries.

Google Play and the Google Play logo are trademarks of Google Inc.

The Bluetooth® word mark and logos are registered trademarks owned by the Bluetooth SIG, Inc. and any use of such marks by Oras Group is under license. Other trademarks and trade names are those of their respective owners.



Lithium 2CR5 6 V
 I (ISO 3822)
 EN 15091
 100 - 1000 kPa

max. +70°C
 IP 55

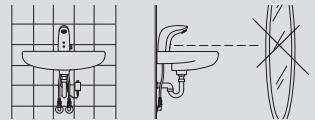

6150FZ ❄️

6150F

6150FZ-080 ❄️ 0.07 l/s / max. 8 s

6150FZ-102 ❄️ 0.028 l/s

6150FZ-104 ❄️ 0.056 l/s

6150FZ-105 ❄️ 0.07 l/s

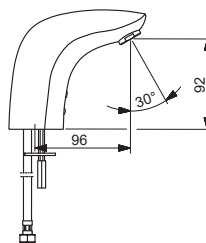
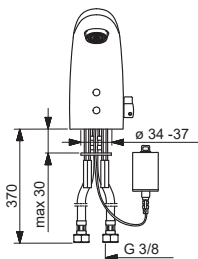

mpi.oras.com/6150FZ

6151FZ ❄️

6151FZ-33 ❄️

6151FZ-104 ❄️ 0.056 l/s

6151FZ-105 ❄️ 0.07 l/s

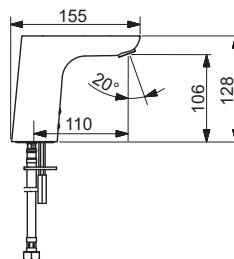
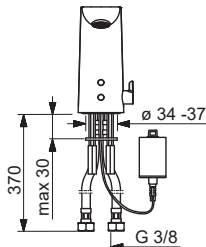

mpi.oras.com/6151FZ

6155FZ ❄️

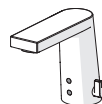
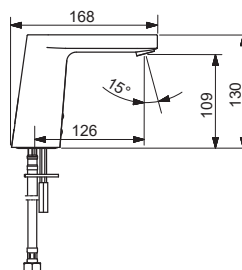
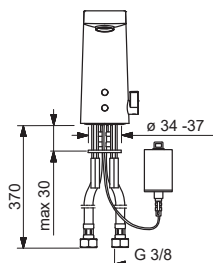

mpi.oras.com/6155FZ

6159FZ ❄️

0.09 l/s

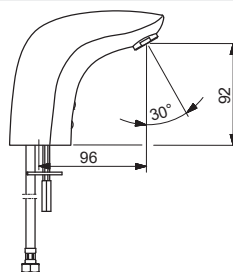
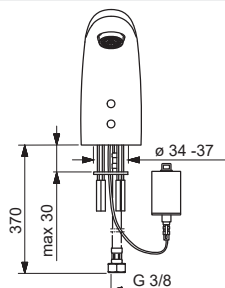

mpi.oras.com/6159FZ

Lithium 2CR5 6 V
 I (ISO 3822)
 EN 15091
 100 - 1000 kPa

max. +70°C
 IP 55

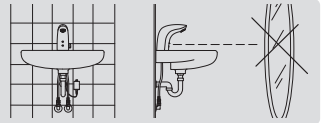

6250FZ

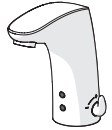
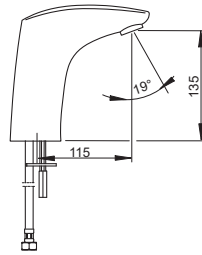
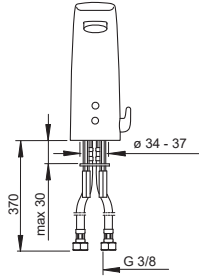

mpi.oras.com/6250FZ

1714FZ 0.08 l/s
1714F
1714FZ-102 0.028 l/s

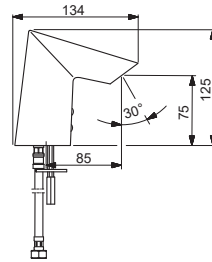
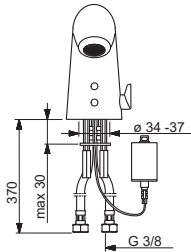

mpi.oras.com/1714FZ

2814FZ

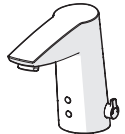
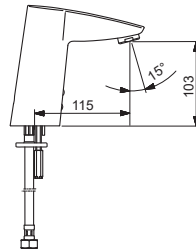
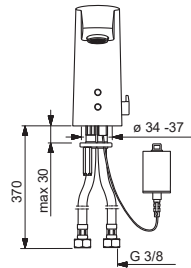

mpi.oras.com/2814FZ

6153FZ

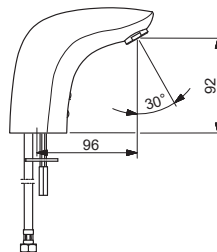
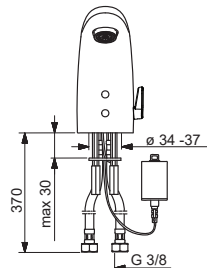

mpi.oras.com/6153FZ



Lithium 2CR5 6 V
 I (ISO 3822)
 EN 15091
 100 - 1000 kPa

max. +70°C
 IP 55

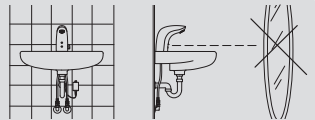

4814FZ

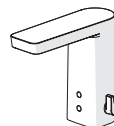
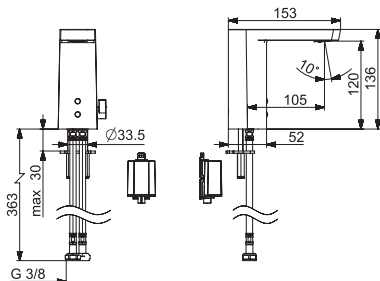

mpi.oras.com/4814FZ

6330FZ

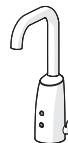
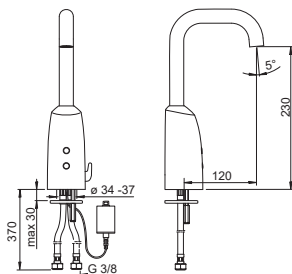

mpi.oras.com/6330FZ

6331FZ

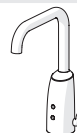
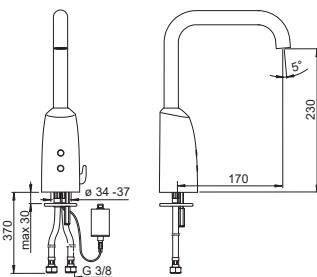

mpi.oras.com/6331FZ

2816FZ

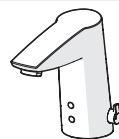
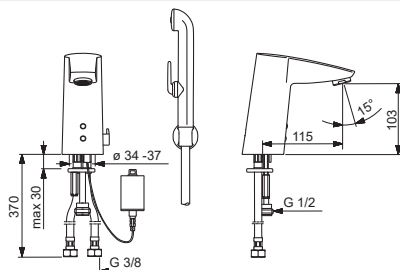

mpi.oras.com/2816FZ



Lithium 2CR5 6 V
I (ISO 3822)
EN 15091
100 - 1000 kPa

max. +70°C
IP 55

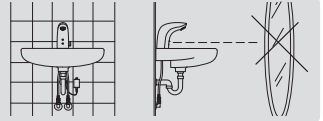

6332FZ

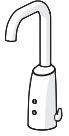
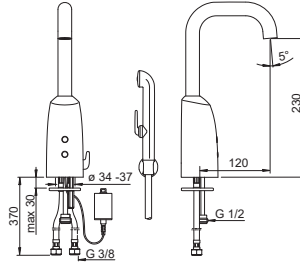

mpi.oras.com/6332FZ

6333FZ

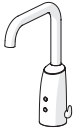
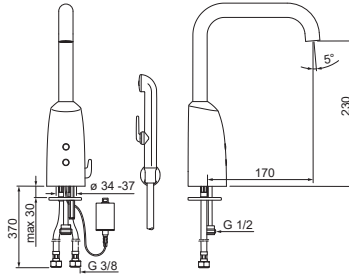

mpi.oras.com/6333FZ

6152FZ 100 - 500 kPa

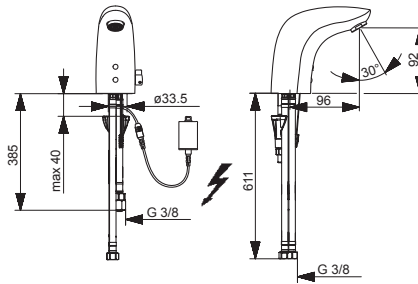

mpi.oras.com/6152FZ



Lithium 2CR5 6 V
I (ISO 3822)
EN 15091
100 - 1000 kPa

max. +70°C
IP 55

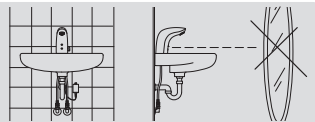

3014F

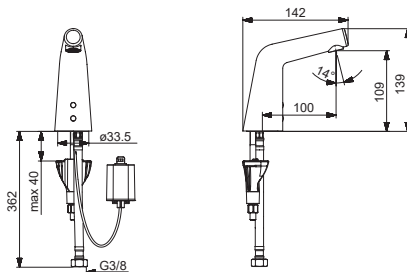

mpi.oras.com/3014F

3016F

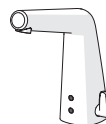
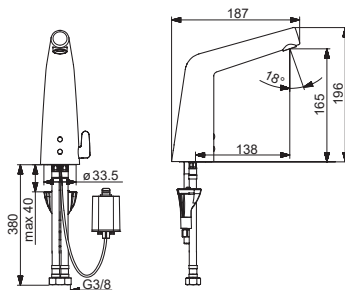

mpi.oras.com/3016F

3017F

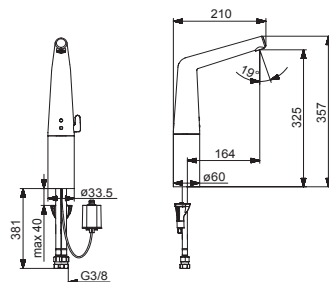

mpi.oras.com/3017F

9 / 12 V
I (ISO 3822)
EN 15091
100 - 1000 kPa

max. +70°C
IP 55

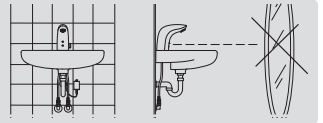

6125FZ

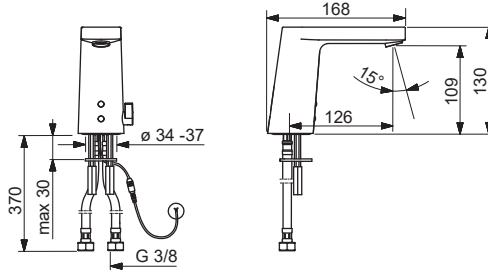

mpi.oras.com/6125FZ

6222FZ

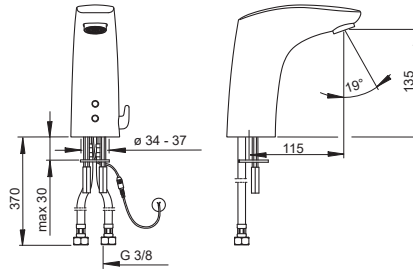

mpi.oras.com/6222FZ

6221FZ 100 - 500 kPa

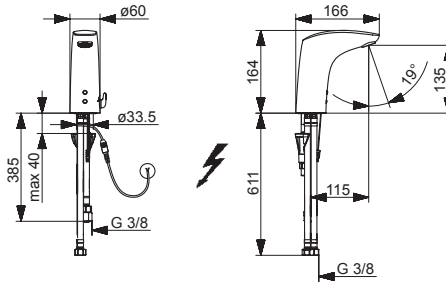

mpi.oras.com/6221FZ

1724FZ

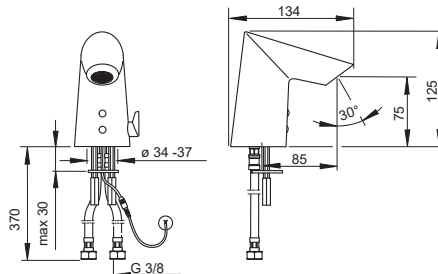

mpi.oras.com/1724FZ



9 / 12 V
I (ISO 3822)
EN 15091
100 - 1000 kPa

max. +70°C
IP 55

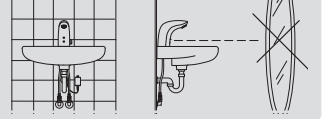

- 6120FZ**
- 6120FZ-080** 0.07 l/s max. 8 s
- 6120FZ-102** 0.028 l/s
- 6120FZ-104** 0.056 l/s

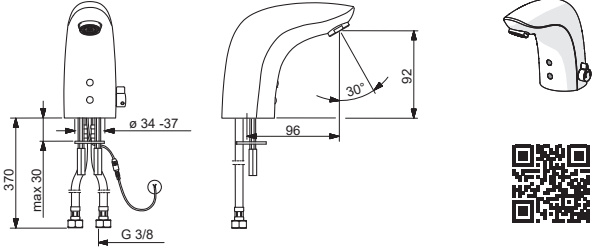

mpi.oras.com/6120FZ

6123FZ

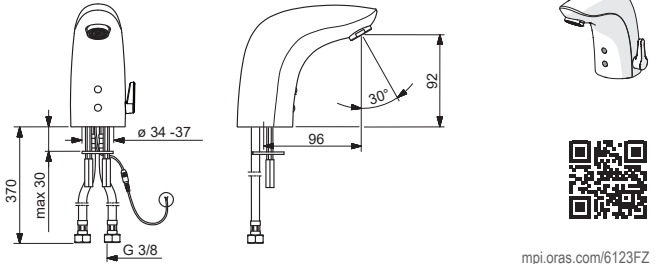

mpi.oras.com/6123FZ

2826FZ
2816FZ

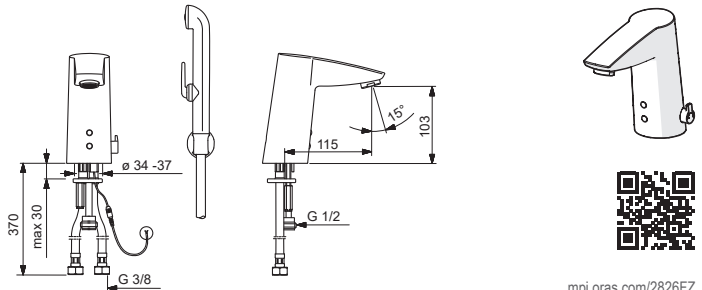

mpi.oras.com/2826FZ

6121FZ

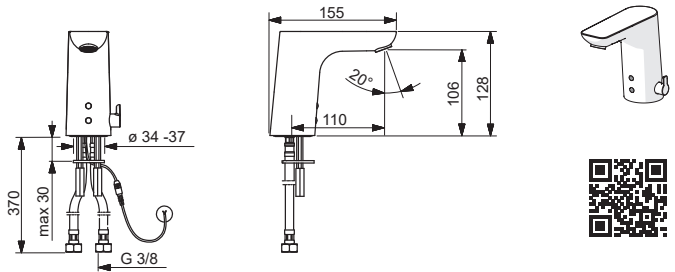

mpi.oras.com/6121FZ

9 / 12 V
 I (ISO 3822)
 EN 15091
 100 - 1000 kPa

max. +70°C
 IP 55

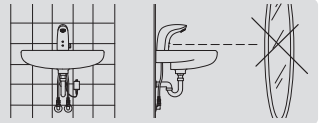

3014FT

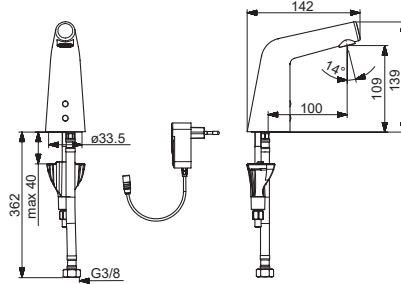

mpi.oras.com/3014FT

3016FT

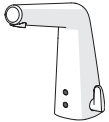
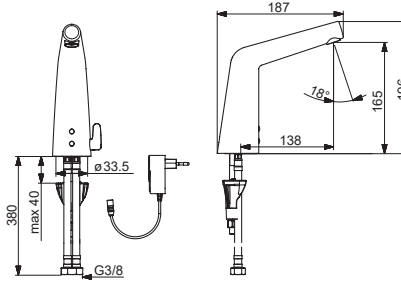

mpi.oras.com/3016FT

3017FT

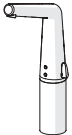
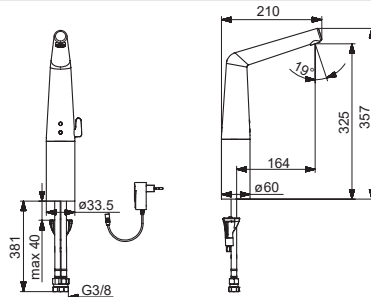

mpi.oras.com/3017FT



230 / 9 V
 I (ISO 3822)
 EN 15091
 100 - 1000 kPa

max. +70°C
 IP 55 / transformer IP 20

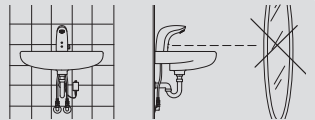

1724FTZ ❄️

0.08 l/s

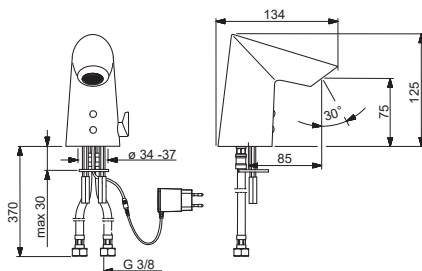

mpi.oras.com/1724FTZ

2824FTZ ❄️

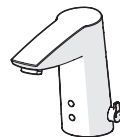
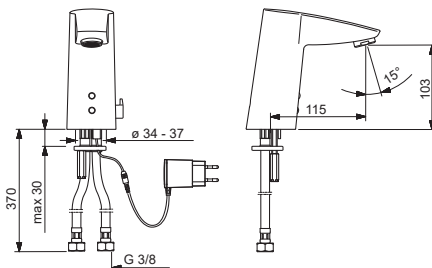

mpi.oras.com/2824FTZ

6120FTZ ❄️

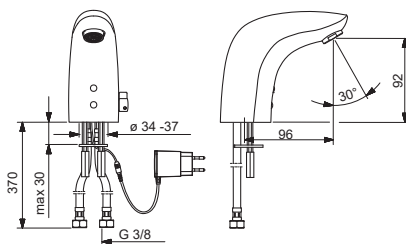

mpi.oras.com/6120FTZ

4824FTZ ❄️

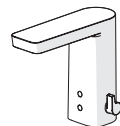
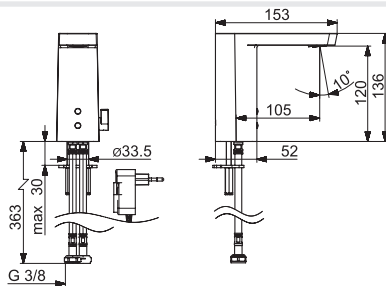

mpi.oras.com/4824FTZ

230 / 9 V
 I (ISO 3822)
 EN 15091
 100 - 1000 kPa

max. +70°C
 IP 55 / transformer IP 20

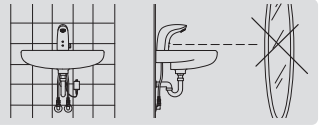

6123FTZ

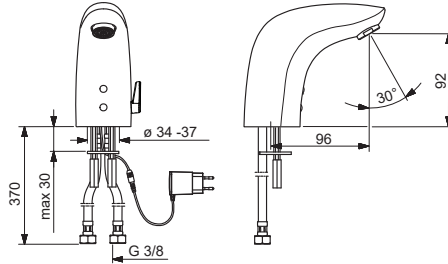

mpi.oras.com/6123FTZ

6223FTZ

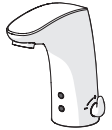
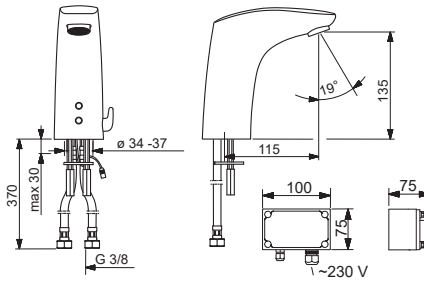

mpi.oras.com/6223FTZ

6334FTZ

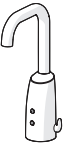
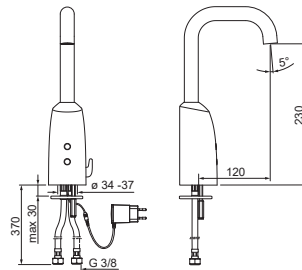

mpi.oras.com/6334FTZ

6335FTZ

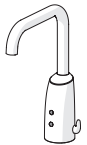
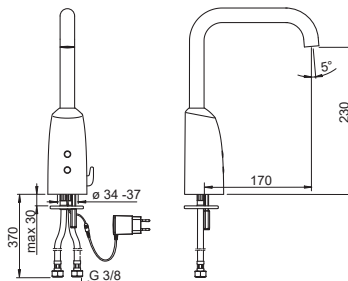

mpi.oras.com/6335FTZ



230 / 9 V
I (ISO 3822)
EN 15091
100 - 1000 kPa

max. +70°C
IP 55 / transformer IP 20

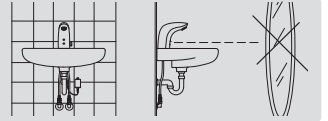

2826FTZ

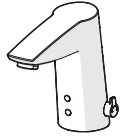
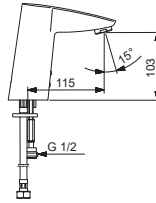
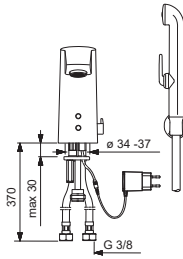

mpi.oras.com/2826FTZ

- GB** Power supply requirement: Power supply output must be short circuit protected
- CZ** Požadavky týkající se napájecího zdroje: Výstup napájecího zdroje musí být chráněn proti zkratu
- DE** Stromversorgungs voraussetzungen: Stromversorgungsspannung muss kurzschlussgeschützt sein.
- DK** Krav til strømforsyning: Strømforsyningsudgang skal være kortslutningsbeskyttet
- EE** Nõuded vooluallikale: Vooluallika väljund peab olema kaitstud lühise eest
- ES** Requisitos del suministro eléctrico: el suministro eléctrico debe estar protegido contra cortocircuitos
- FI** Vaatimukset virtälähteelle: Virtälähteen ulostulon tulee olla oikosulkusuojattu
- FR** Unité d'alimentation électrique: La sortie de l'unité d'alimentation oit être protégée contre le court-circuit
- IT** Requisiti dell'alimentazione: L'uscita deve essere protetta da cortocircuiti
- LT** Reikalavimai maitinimo šaltiniui: turi būti apsauga nuo trumpo jungimo
- LV** Prasības attiecībā uz barošanas ierīci: ierīces izvadām jābūt aizsargātām pret īsslēgumiem
- NL** Vereisten voor de voeding: De uitgang van de voeding moet beschermd zijn tegen kortsluitingen
- NO** Krav til strømforsyning: Strømforsyningspenning må være kortslutningssikret
- PL** Wymagania w stosunku do zasilacza: Zasilacz musi być wyposażony w zabezpieczenie przeciwzwarciowe
- RO** Pentru alimentarea cu putere: borna de putere trebuie să fie protejată la scurtcircuit
- RU** Требования к источнику тока: Выход источника тока защищен от короткого замыкания
- SE** Krav på matningsdön: Utspänningen skall vara kortslutningssäker
- SK** Požiadavka na napájanie: Výstup napájania musí byť chránený voči skratu.
- UA** Вимоги до джерела струму: Вихід джерела струму захищений від короткого замикання.
- PT** Requisitos de alimentação eléctrica: a alimentação eléctrica deve estar protegida contra curto-circuito.
- GR** Προϋποθέσεις για αδιάλειπτη παροχή ρεύματος: Τάση εξόδου ασφαλισμένη έναντι βραχυκυκλώματος
- SI** Zahteva za napajanje: Izhod za napajanje mora biti zaščiten s kratkim stikom
- HU** Áramellátás: A tápegység kimeneténél fontos az érintésvédelmet biztosítani.

Oras 199275

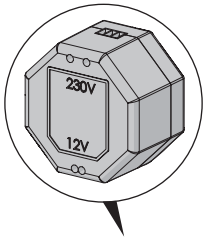
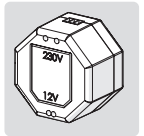

Oras 199275

1.....5

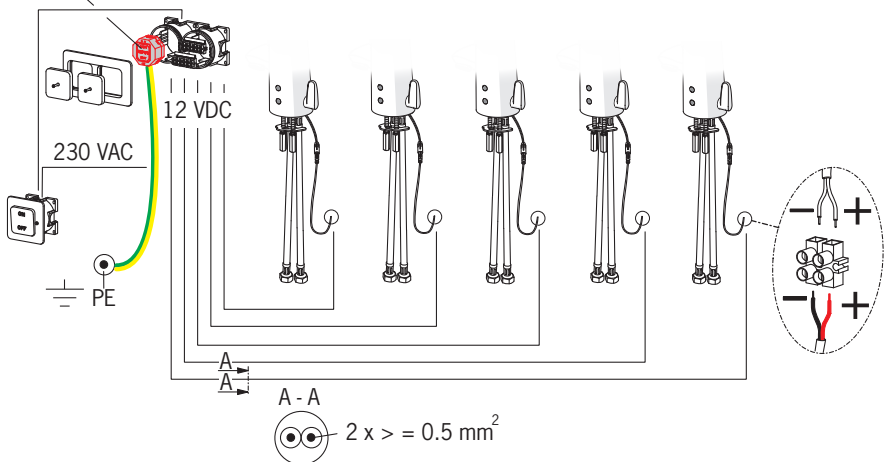

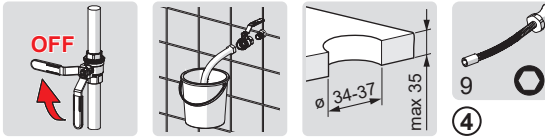

1 A

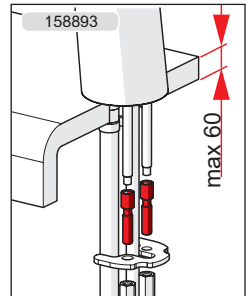
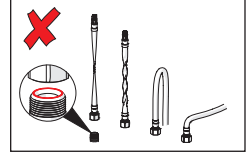
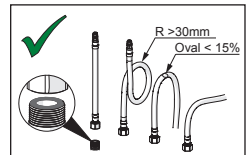
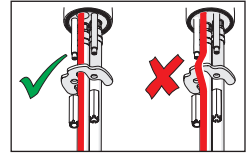
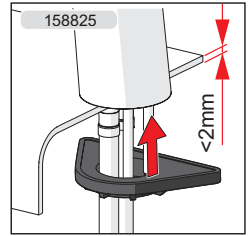
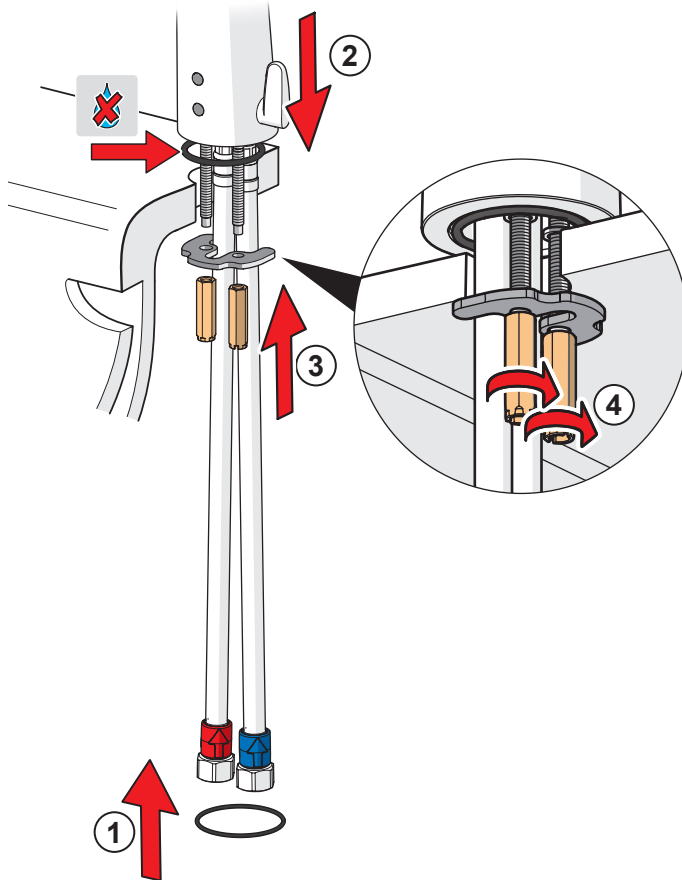

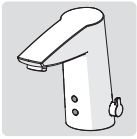
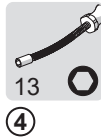
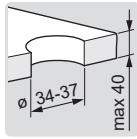
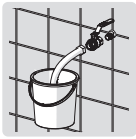
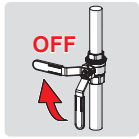

1 B

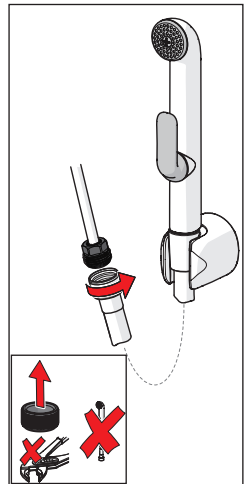
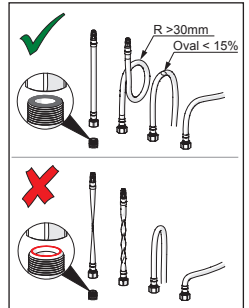
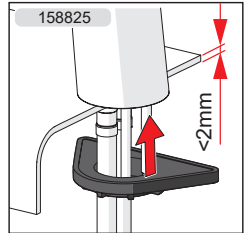
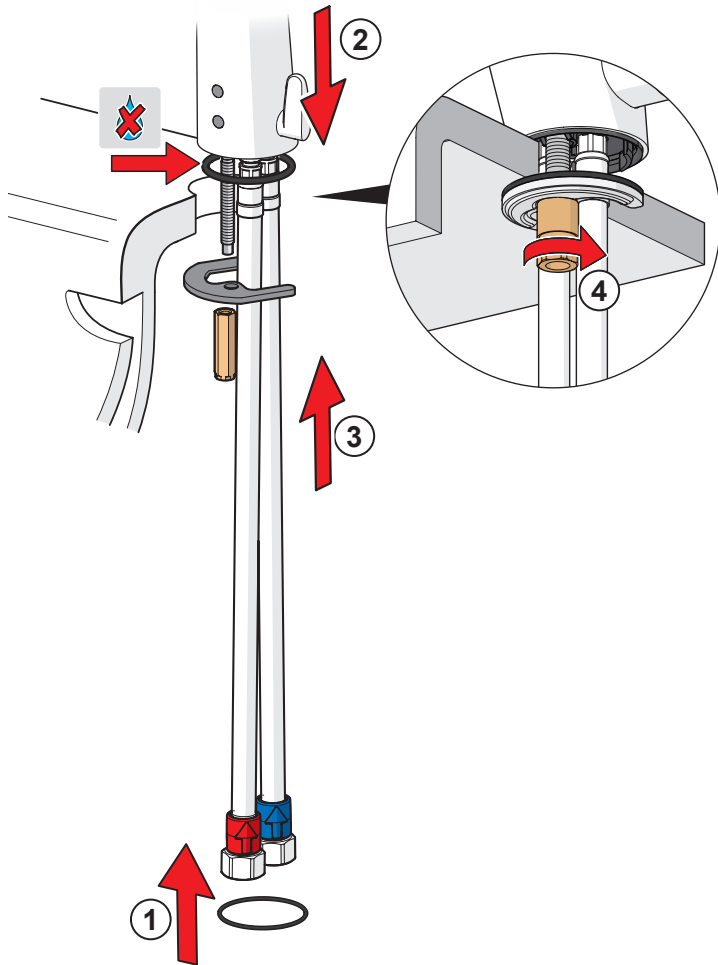

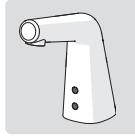
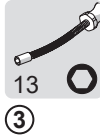
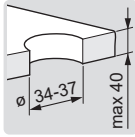
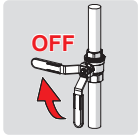

1 C

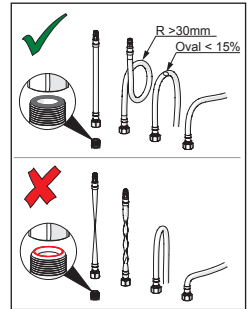
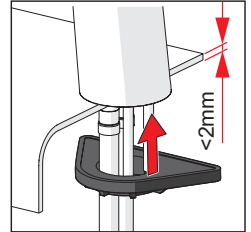
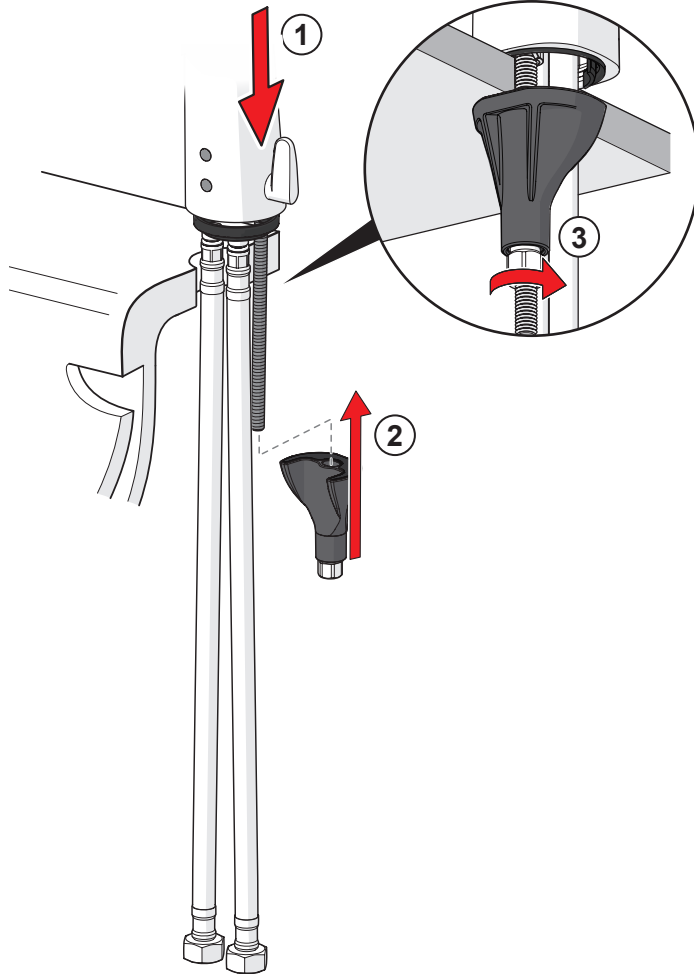

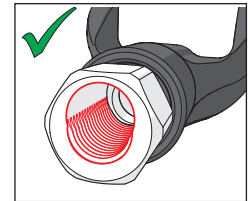
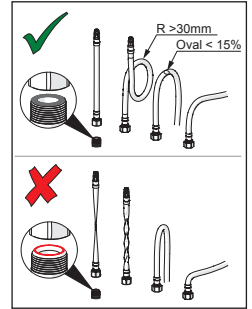
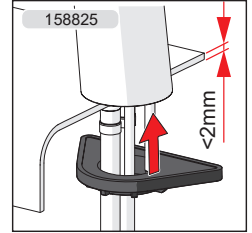
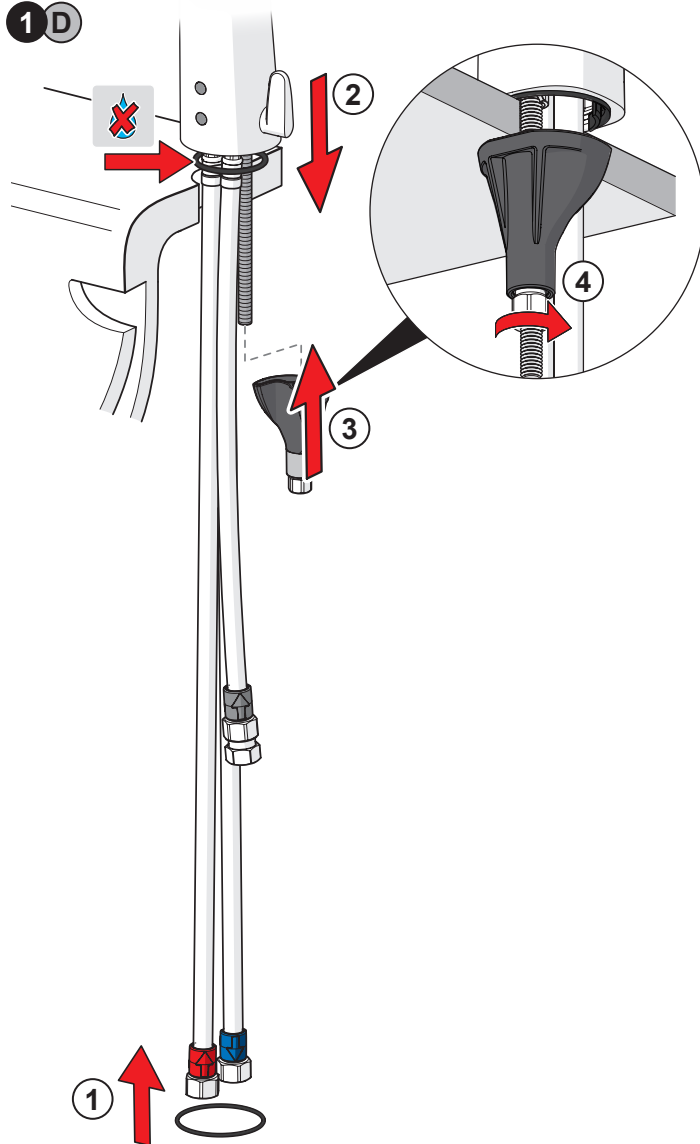
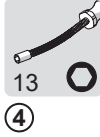
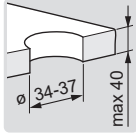
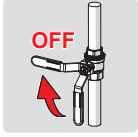



1 2

max.
1600 kPa

2 A

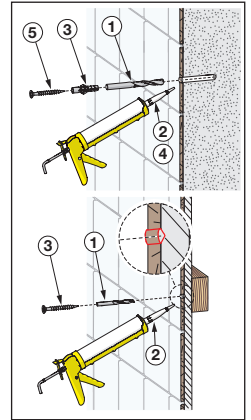
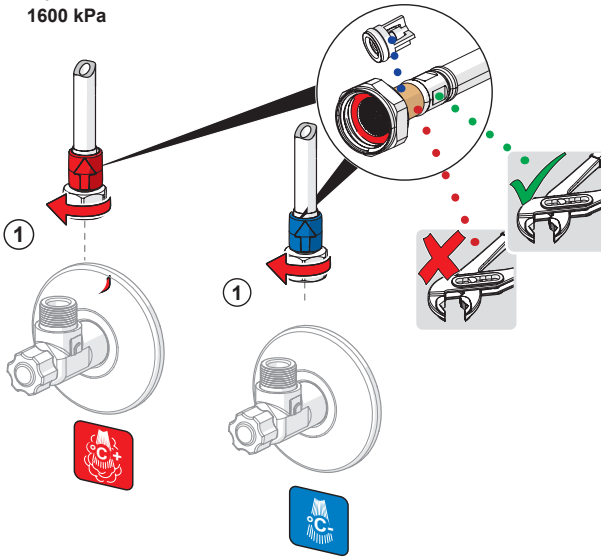

2 B

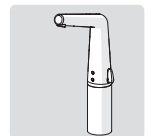
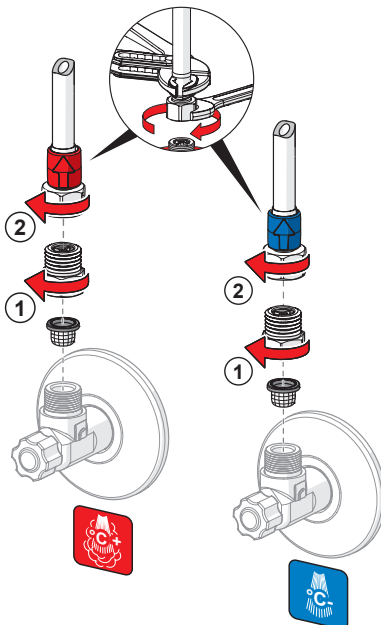

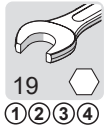

max.
1600 kPa

2C

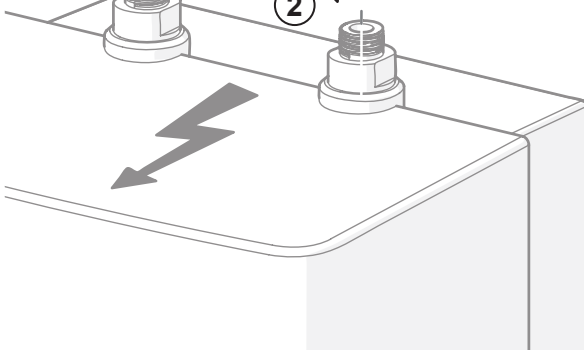
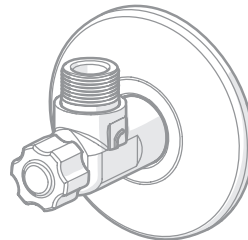
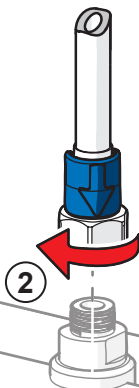
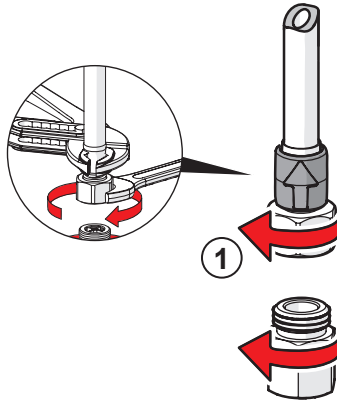



3 A

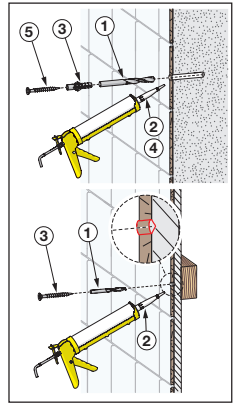
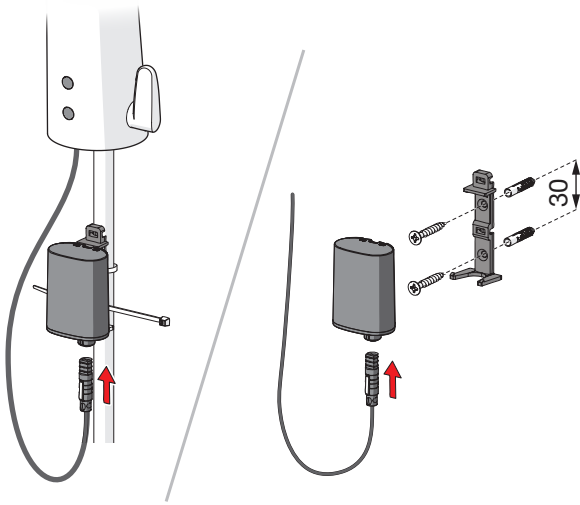

3 B

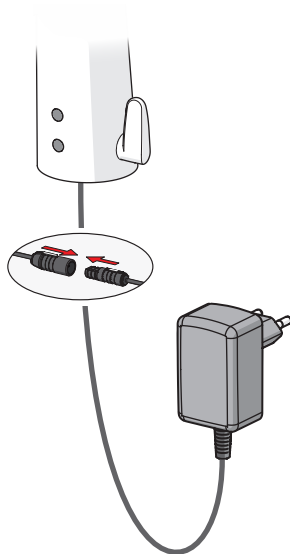

199550

3 C

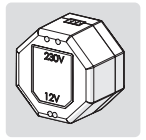
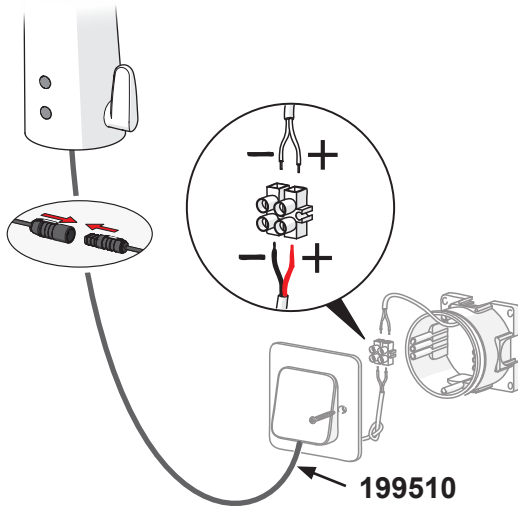

199275

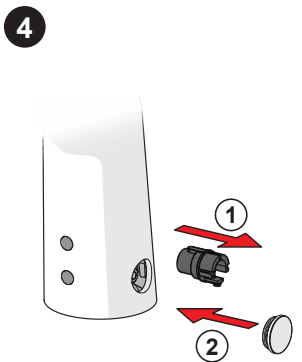
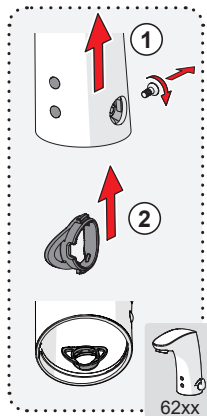
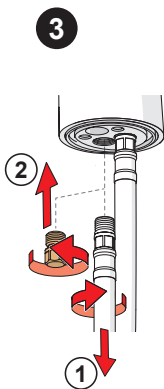
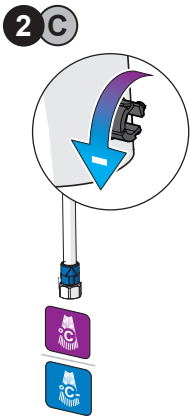
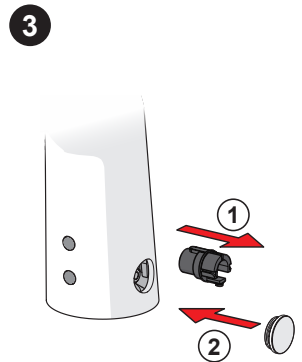
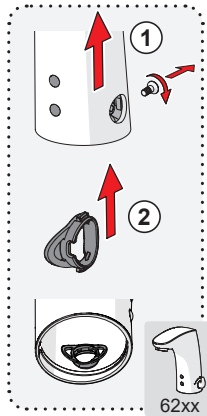
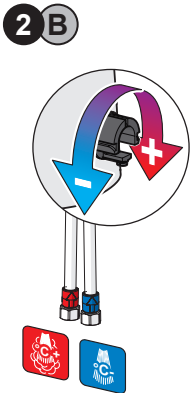
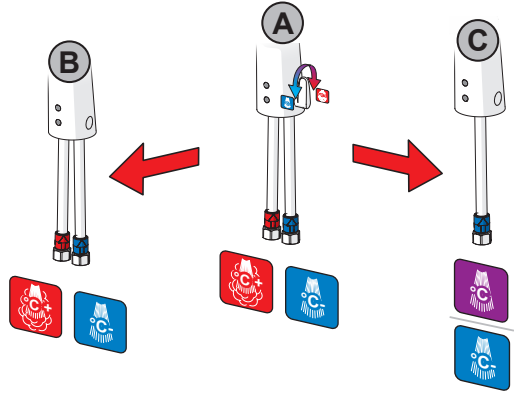
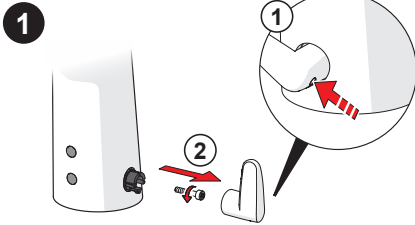
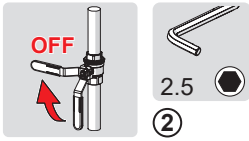



AUTOMATIC

2 s ± 1 s

max. 2 min

Bluetooth®

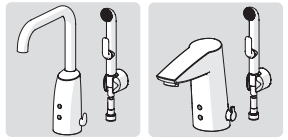
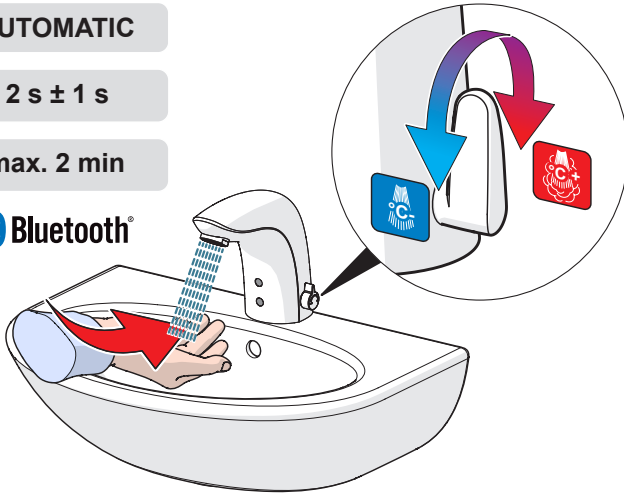

1 ON

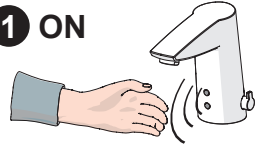

2



3 OFF

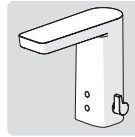
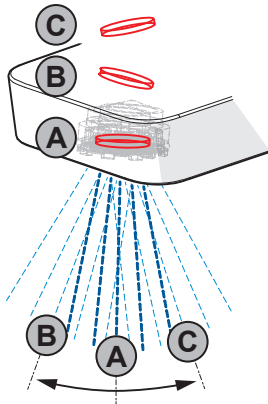

Oras App



apps.oras.com



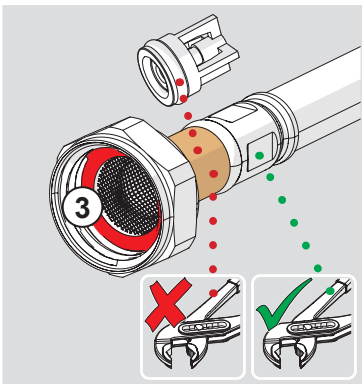
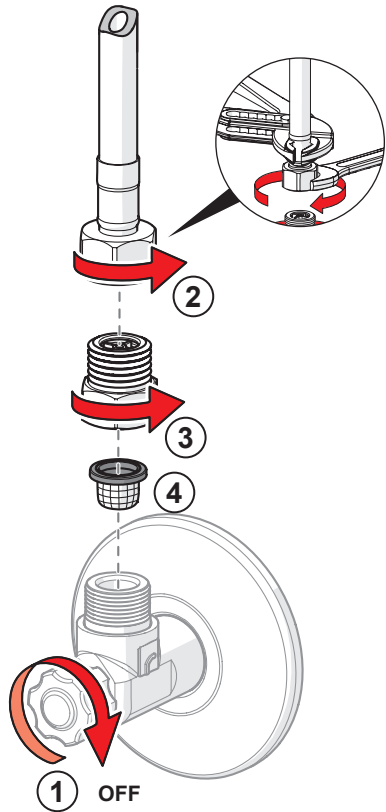
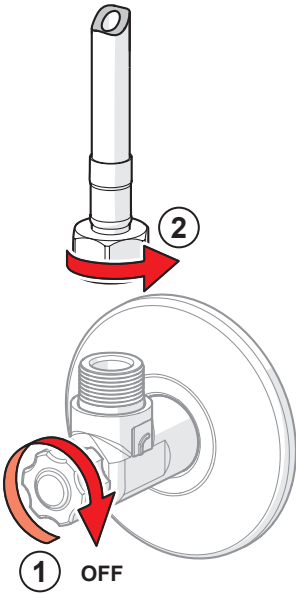
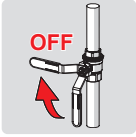
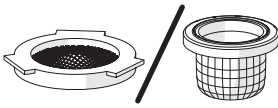



Lithium 2CR5 6V

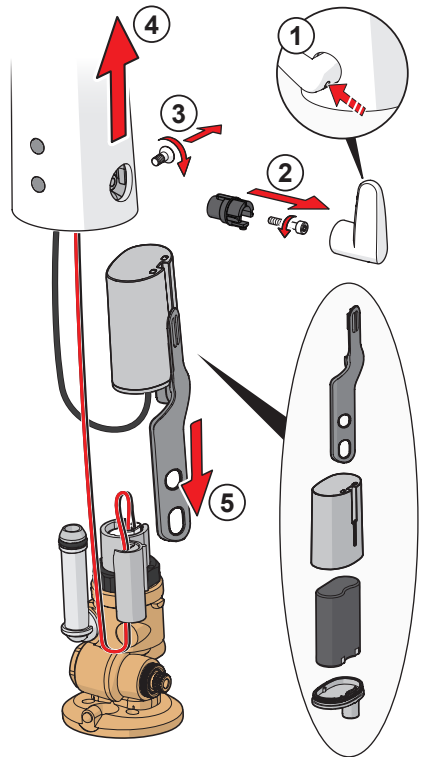
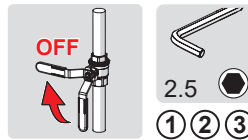
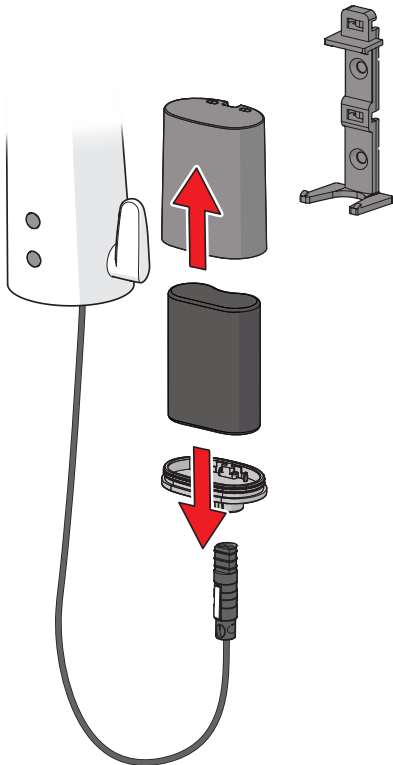



2.5

① ②

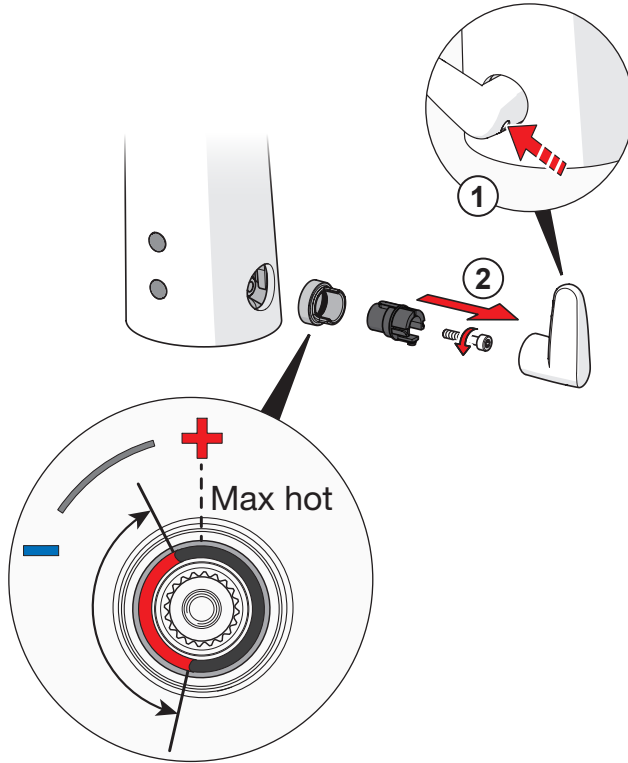

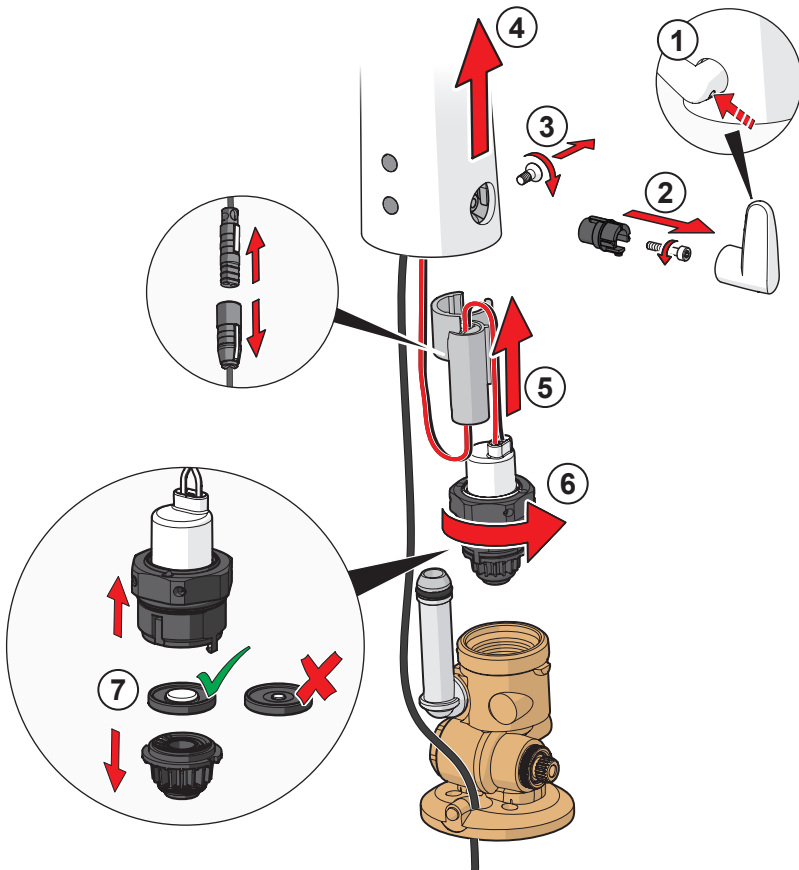
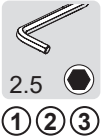
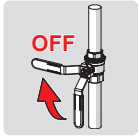

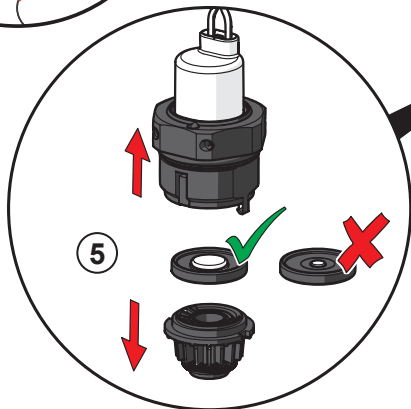
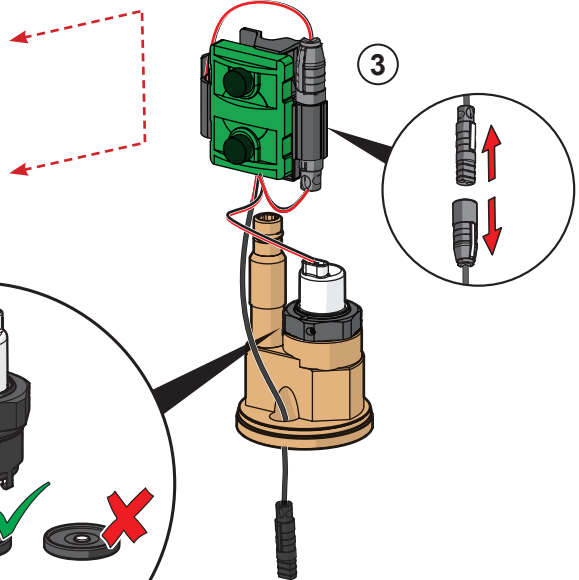
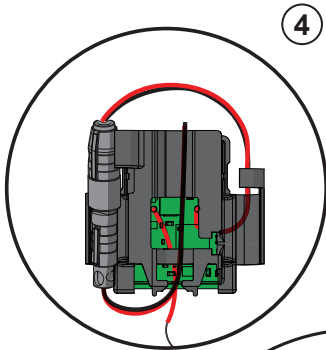
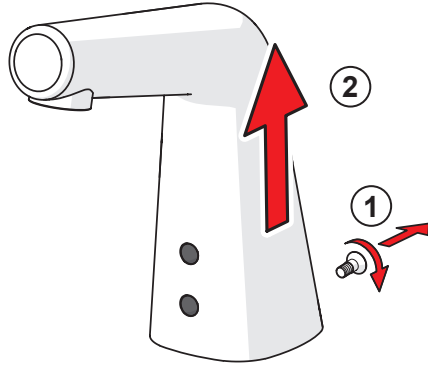
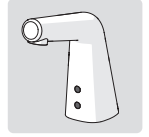
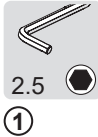
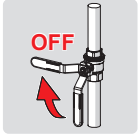

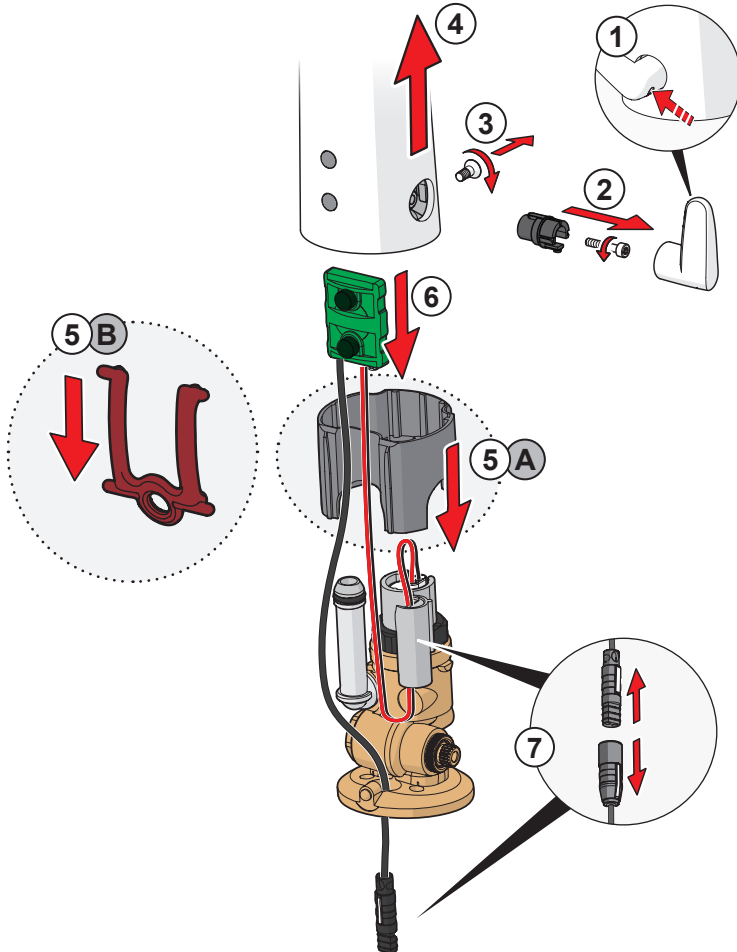
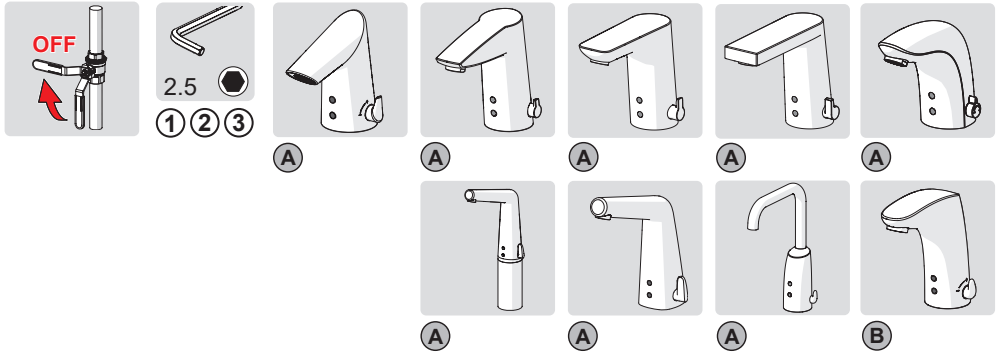

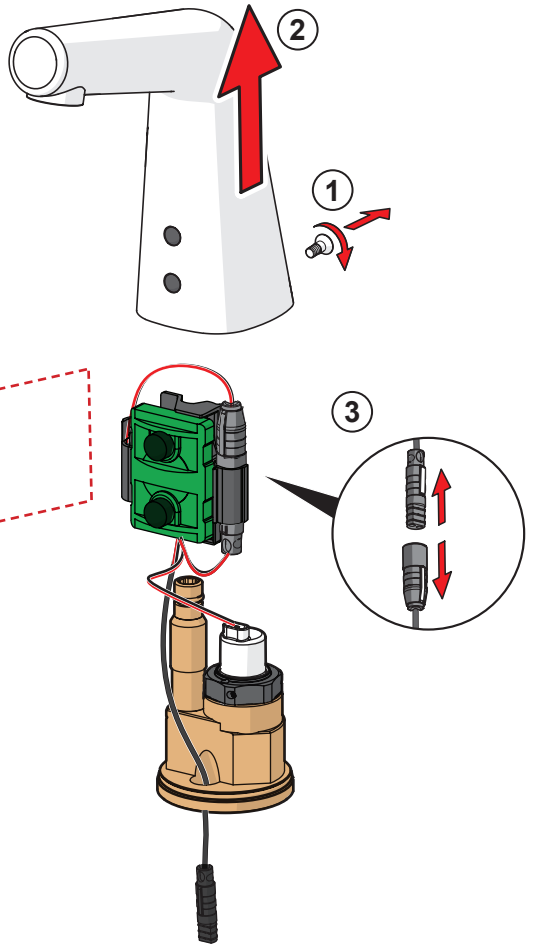
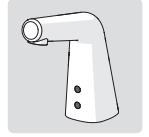
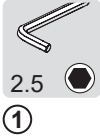
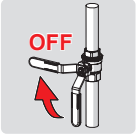

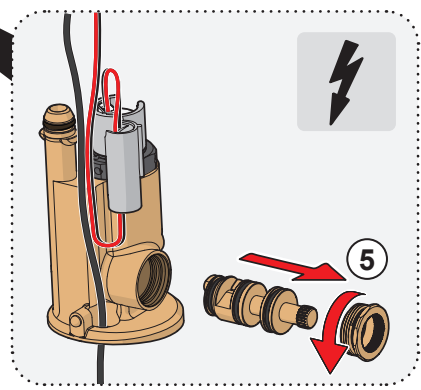
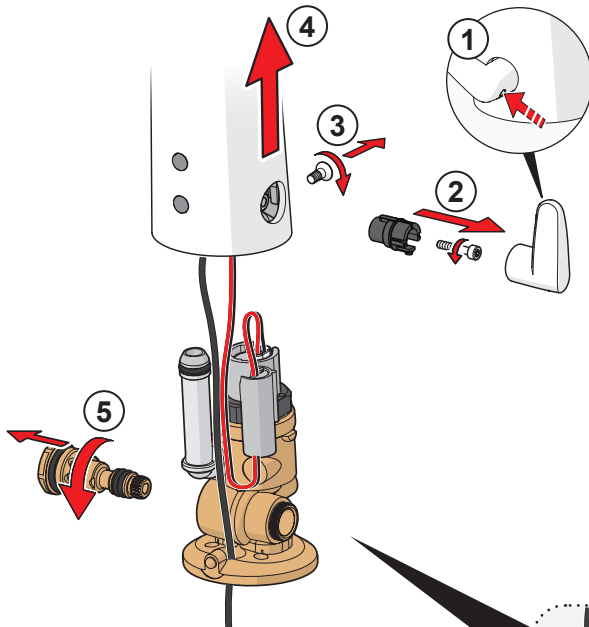
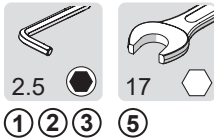
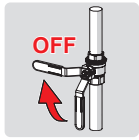



Bluetooth®

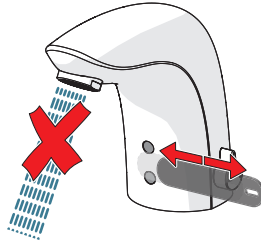
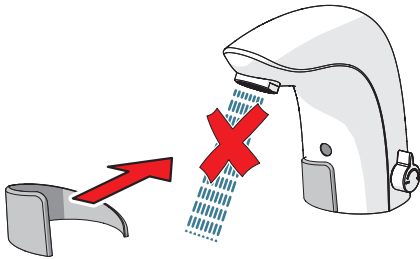

- 1 ON
- 2
- 3
- 4
on 30 s (factory settings)
- 5 automatic off
off

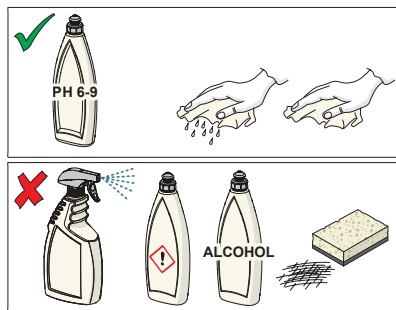
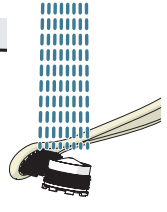
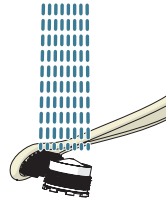
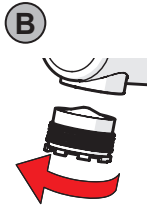
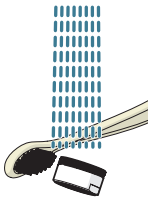
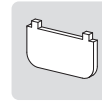
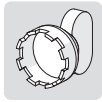

cleaning.oras.com

Oras Group is a powerful European provider of sanitary fittings: the market leader in the Nordics and a leading company in Continental Europe. The company's mission is to make the use of water easy and sustainable and its vision is to become the European leader of advanced sanitary fittings. Oras Group has two strong brands: Oras and Hansa.

The Group's head office is located in Rauma, Finland, and the Group has three manufacturing sites: Kralovice (Czech Republic), Olesno (Poland) and Rauma (Finland). Oras Group employs approximately 1,200 people in twenty countries. Oras Group is owned by Oras Invest, a family company and an industrial owner.

ORAS Ltd
Isometsäntie 2, P.O. Box 40
FI-26101 Rauma
Tel. +358 2 83 161
Fax +358 2 831 6300
info.finland@oras.com
www.oras.com



943421-01-21